

GES/UCAS

Graphic specifications

UCAS



This document

- This document contains an overview of GES/UCAS Graphic Specs;
 - Infill graphic specification
 - Overlay graphic specification
 - Stand measurements
 - Graphic fitting
 - Overview
 - Top tips
 - Contact information

Infill graphics

- Sit in between the metal framework
- Attach directly to the panel board
- Dimensions: Height 2340mm x Width 923mm

- Use hook and loop Velcro to attach graphics to panels.

(Please note image is just an example of graphic fit on the shell scheme. The UCAS design of stand will not have a fascia)



Overlay graphics

- Graphics will be overlaying the poles as per the visual to sit flush next to each other for a continued design across all panels.
- **Please note**
- Image is just an example of graphic fit on the shell scheme – our design of stand will not have a fascia)
- For all graphics printed we would recommend printing on a 3mm (thickness) Foamex board.

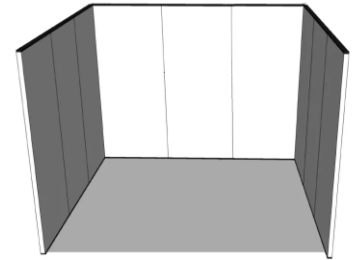
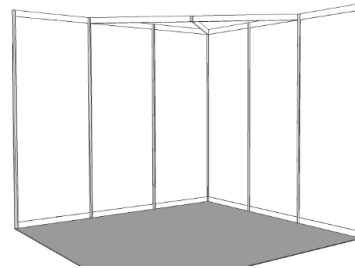

Overlay graphic fitting

- Recommend using shell clips to attach the overlay graphics to the shell scheme.
- These attach to the aluminium upright supports and push into place.
- These are available from a number of outlets. For example: [shell-clad.com](https://www.shell-clad.com)

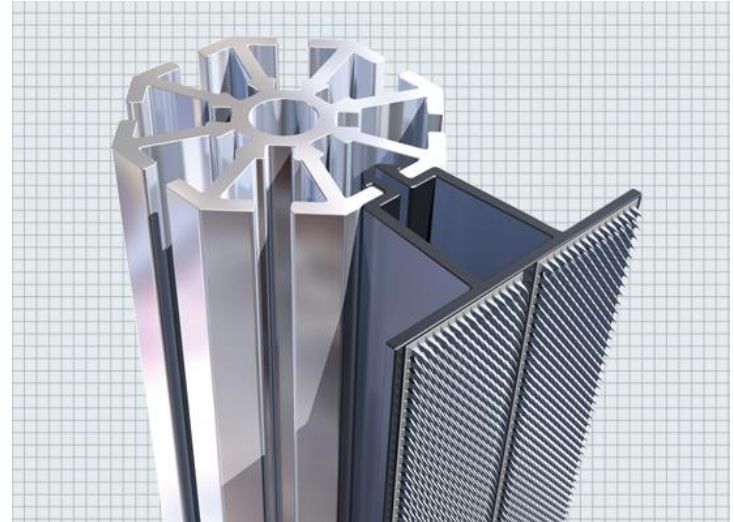

Overlay graphics stand measurements

Measurements as follows, all at height 2430mm:

3x2m with 3 walls

Back wall – 2906mm
Side walls – 1914mm

3x2m with 2 walls

Back wall – 2906mm
Side walls – 1914mm

6x2m with 3 walls

Back wall – 5882mm
Side walls – 1914mm

6x2m with 2 walls

Back wall – 5882mm
Side walls – 1914mm

End of block

4x3 End of block back wall 3898mm
4x6 End of block back wall 3898mm

Per panel dimensions:

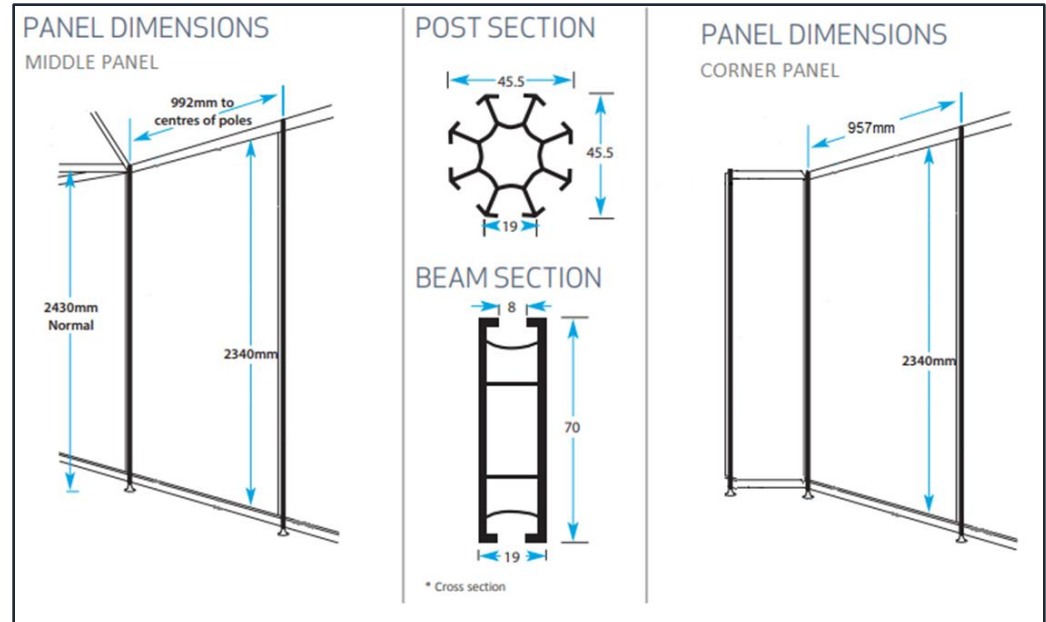

Overview

UCAS

Discovery

Inlay panel sizes

Full panel – (w) 923mm x (h) 2340mm



Overlay panel sizes

2m wall – (w) 1914mm x (h) 2430mm (panel width breakdown 957/957) 2m wall

(without a support end panel) – (w) 1969mm x (h) 2430mm (panel width breakdown

957/1012) 3m wall – (w) 2906mm x (h) 2430mm (panel width breakdown 957/992/957)

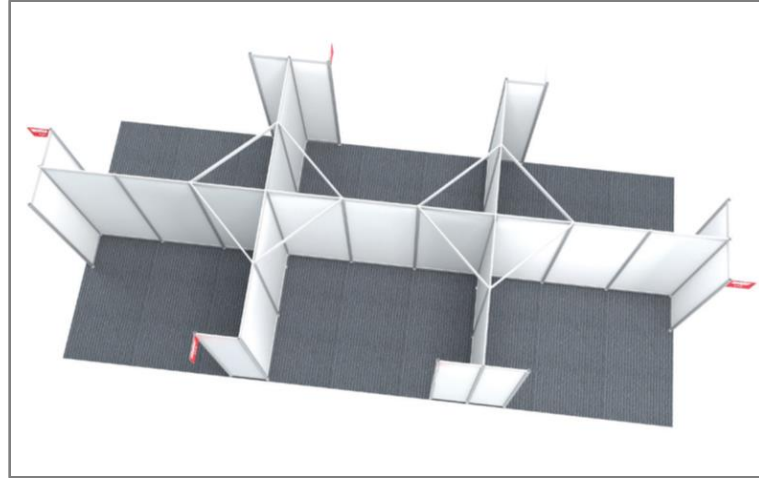

**graphic measurements are calculated in accordance with GES production methods

Top Tips

- Please ensure graphics are to the correct specification when ordering, to avoid disappointment.
- Stand builders and designers will have experience with working with shell scheme stands, please ensure you share this document with yours.
- All stands will have 2 top support beams shown here in the images. If your structure is freestanding please ensure it fits below the top support beam to avoid altering the structural stability of the shell scheme.
- All stands will have a nameboard panel at the end as shown in image on right, remember to take this into account when designing your stand.
- Please note middle panels are wider than the corner panels as per dimensions in previous slides, please take this into account when designing your stand.
- If you have a complex build stand that sits higher than the the shell scheme please contact events@ucas.ac.uk for help with your stand.

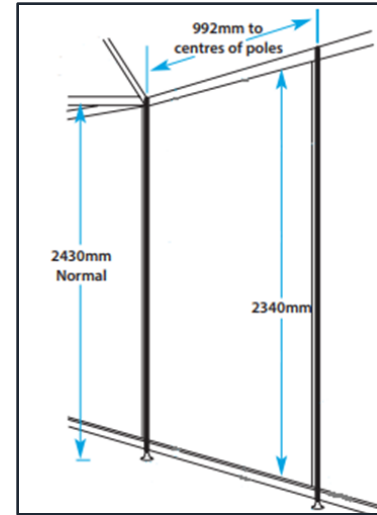

UCAS

Discovery

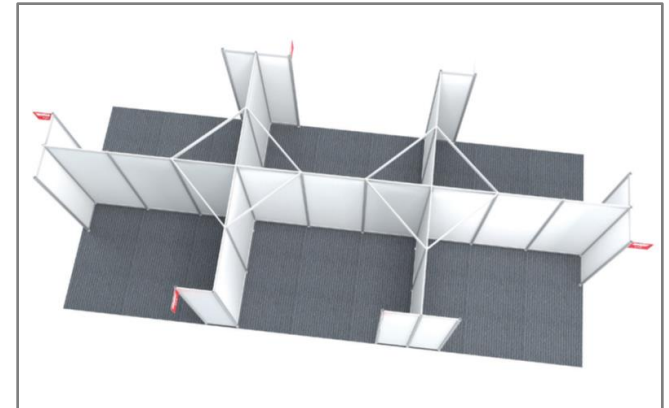

Top Tips

Features of a shell scheme stand:

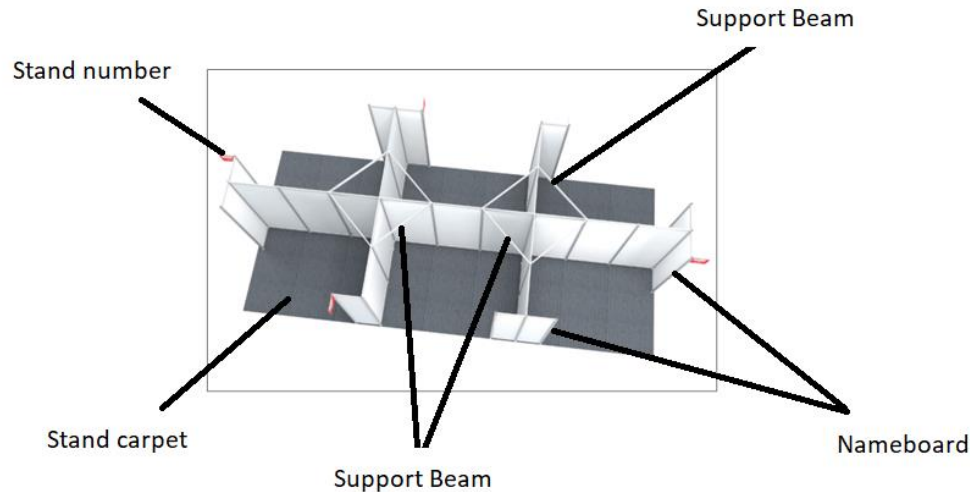

DO'S & DON'TS

We hope you find your shell scheme in order. Please observe the do's and don'ts associated with this system.

The use of the fixings below is strictly forbidden on this system:



FIXING IS PERMITTED BY:

Melamine/Vinyl Panels

- Double sided tabs
- Velcro hook and loop
- Panel brackets
- Hanging chains for heavy exhibits

Loop Nylon Panels

- Velcro hook
- Panel brackets
- Hanging chains for heavy exhibits

GES approved d/s pads and Velcro tape only to be used (available for sale at the front of the halls at the Service Desk)

UCAS

Discovery

Contact information

If you have any queries

UCAS

Tel: 01242 544 808

Email: events@ucas.ac.uk

Direct to GES care team

Call us today: +44 (0)2476 380 190

Monday - Friday 08:30 - 17:00 GMT